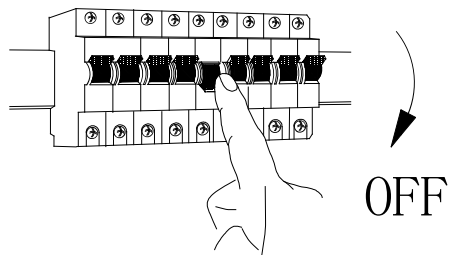
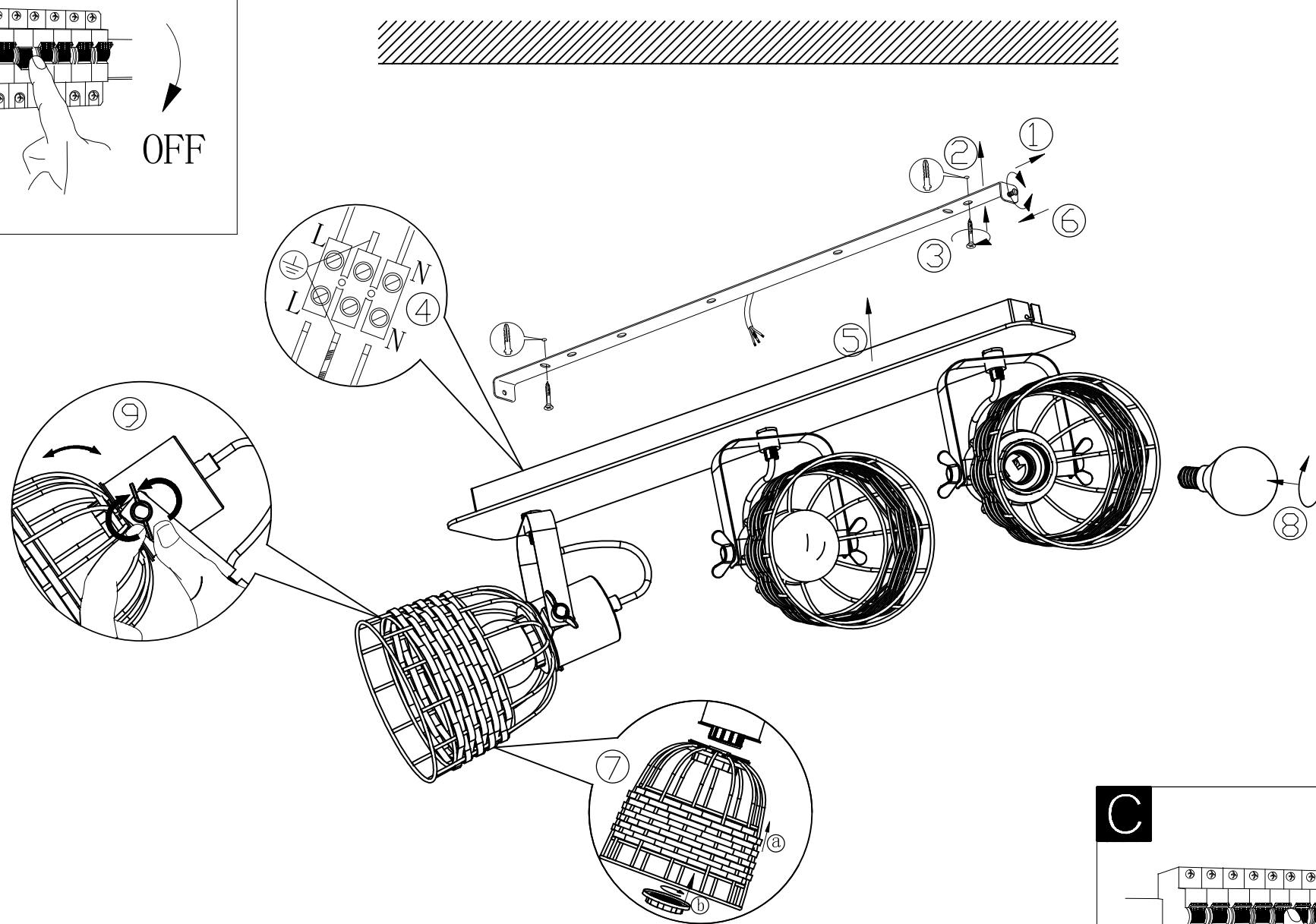
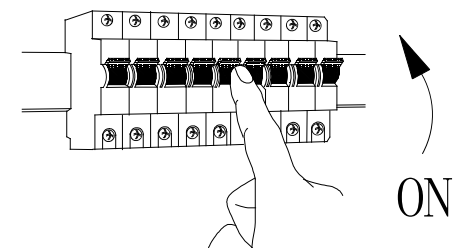

A**B****C**

B43326
www.eglo.com